

Data Sheet



Article number: 201576306

Description: E+G Handwheel
GN 950.6-140-K14-F

Measures

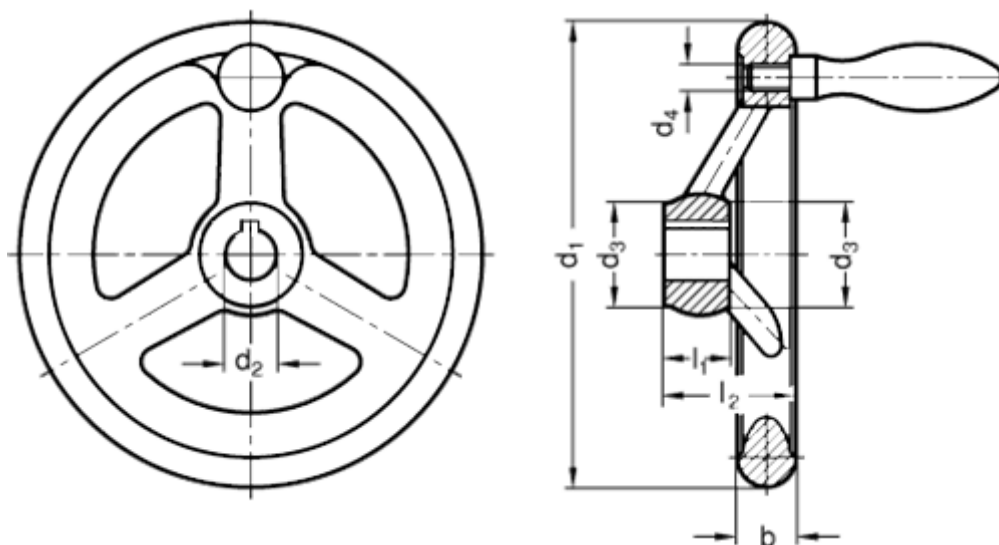

$b_1 = 17.0$

$d_1 = 140$

$d_2 = 14$

$d_3 = 29.0$

$d_4 = M8$

$l_1 = 19$

$l_2 = 38.5$